

4MP Vandal-resistant IR Fixed Mini Dome Camera

IPC314SR-DVPF28 (36)



Key Features

Optics

- Day/night functionality
- Smart IR, up to 15 m (49 ft) IR distance
- 2D/3D DNR (Digital Noise Reduction)
- Up to 120 dB Optical WDR(Wide Dynamic Range)

Compression

- Ultra 265,H.265, H.264, MJPEG
- Embedded smart algorithm
- Triple streams
- ROI (Region of Interest)

Network

- ONVIF Conformance

Structure

- Wide temperature range: -35°C to 60°C (-31°F to 140°F)
- Wide voltage range of $\pm 25\%$
- Built-in microphone
- IK10 vandal resistant
- IP66

Specifications

	IPC314SR-DVVPF28	IPC314SR-DVVPF36
Camera		
Sensor	1/3", progressive scan, 4.0 megapixel, CMOS	
Lens	2.8mm@F2.0	3.6 mm@F2.0
Angle of View (H)	101.8°	76.8°
Shutter	Auto/Manual, 1/6~1/100000 s	
Minimum Illumination	Colour: 0.02 Lux (F2.0, AGC ON) 0 Lux with IR	
Day/Night	IR-cut filter with auto switch (ICR)	
Digital noise reduction	2D/3D DNR	
S/N	≥55 dB	
IR Range	Up to 15m (49 ft) IR range	
Defog	Digital Defog	
WDR	120dB	
Video		
Video Compression	Ultra 265,H.265, H.264,MJPEG	
H.264 code profile	Baseline profile, Main Profile, High Profile	
Frame Rate	Main Stream:4MP (2592×1520): Max. 20 fps, 4MP (2560×1440): Max. 25 fps, 3MP (2048×1520): Max. 30 fps; Sub Stream:2MP (1920×1080): Max. 30 fps; Third Stream:D1(720×576) : Max. 30fps	
HLC	Supported	
BLC	Supported	
9:16 Corridor Mode	Supported	
OSD	Up to 8 OSDs	
Privacy Mask	Up to 8 areas	
ROI	Up to 8 areas	
Motion Detection	Up to 4 areas	
Smart		
Behavior Detection	Intrusion, cross line, motion detection	
Exception Detection	Audio detection	
Intelligent Identification	Face detection, Defocus, Scene Change	
Statistical Analysis	People counting	
General Function	Watermark, IP Address Filtering, Tampering Alarm, Access Policy, ARP Protection, RTSP Authentication, User Authentication	
Audio		
Audio Compression	G.711	
Suppression	Supported	
Suppression	Supported	
Sampling Rate	8 KHZ	
Storage		
Edge Storage	Micro SD, Up to 128 GB	
Network Storage	ANR	

Network	
Protocols	IPv4, IGMP, ICMP, ARP, TCP, UDP, DHCP, PPPoE, RTP, RTSP, RTCP, DNS, DDNS, NTP, FTP, UPnP, HTTP, HTTPS, SMTP, 802.1x, SNMP
Compatible Integration	ONVIF(Profile S, Profile G), API
Interface	
Audio I/O	Audio cable
	Input: impedance 35 k Ω ; amplitude 2 V [p-p]
	Output: impedance 600 Ω ; amplitude 2 V [p-p]
Built-in Mic	Supported
Network	1 RJ45 10M/100M Base-TX Ethernet
General	
Power	12 V DC \pm 25%, PoE (IEEE 802.3af)
	Power consumption:Max 5W
Dimensions (ϕ x H)	ϕ 110 x 61 mm (ϕ 4.3" x 2.4")
Weight	0.25 kg (0.55 lb)
Working Environment	-35°C ~ +60°C (-31°F ~ 140°F), Humidity:10%~95% RH(non-condensing)
Ingress Protection	IP66
Vandal Resistant	IK10

Dimensions

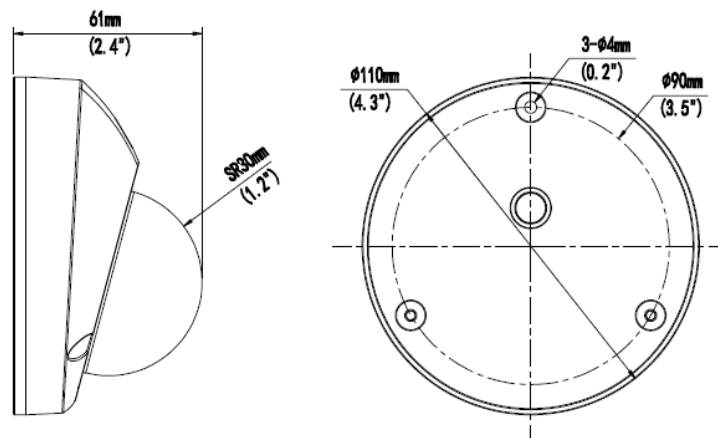

Installation

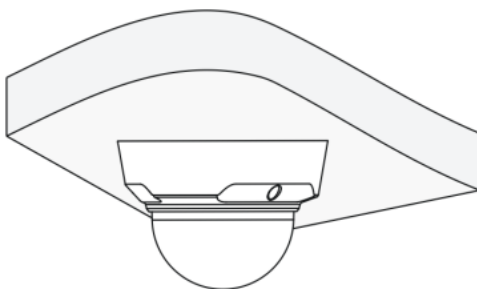

Ceiling mount

Accessories

Installation mode	Accessories	Description
Ceiling mount	Mounting pedestal is included in the Product package	\

Zhejiang Uniview Technologies Co., Ltd.

South Tower, Building 10, Wanlun Science Park, 88 Jiangling Road, Hangzhou, P.R.China 310051

Email: overseasbusiness@uniview.com; globalsupport@uniview.com

<http://www.uniview.com>

©2016-2017 Zhejiang Uniview Technologies Co., Ltd. All rights reserved.

*Product specifications and availability are subject to change without notice.