

# 2MP 33X 2MP Starlight IR Dome Camera

IPC6252SR-X33U



## Key Features

### Optics

- 33X Optical Zoom
- Starlight illumination
- Accurate and fast focusing
- Smart IR, up to 200 m (656ft) IR distance
- Up to 120 dB WDR(Wide Dynamic)
- IR anti-reflection window to increase the infrared transmittance

### Compression

- Ultra 265,H.265, H.264, MJPEG
- Embedded smart algorithm
- Triple streams
- Customized OSD

### Network

- ONVIF Conformance

## Structure

- 15° Elevation Angle
- Innovative snow-removing functionality
- More effective heat dissipation system
- Intelligent temperature control technology
- 6 KV surge protection designed for network interface

## Specifications

	IPC6252SR-X33U
<b>Camera</b>	
Sensor	1/2.8", progressive scan, 2.0 megapixel, CMOS
Lens	4.5 ~ 148.5 mm (33x optical zoom) , AF automatic focusing and motorized zoom lens
Angle of View (H)	62.93° (wide) ~ 3.76° (tele)
Shutter	Auto/Manual; shutter time: 1/6 s ~ 1/100000 s
Minimum Illumination	Colour: 0.001Lux (F1.6,AGC ON) 0 Lux with IR
Iris	Auto/Manual; F1.6 ~ F5.3
Day/Night	IR-cut filter with auto switch (ICR)
Digital noise reduction	2D/3D DNR
S/N	>52dB
IR Range	UP to 200m (656ft)
Defog	Digital Defog
WDR	120dB
<b>Video</b>	
Video Compression	Ultra 265,H.265, H.264, MJPEG
H.264 code profile	Baseline profile, Main Profile, High Profile
Frame Rate	Main Stream:2MP (1920×1080):Max. 60 fps; Sub Stream:2MP (1920×1080):Max. 60 fps; Third Stream: D1 (720×576): Max. 60 fps
HLC	Supported
BLC	Supported
EIS	Supported
OSD	Up to 8 OSDs
Privacy Mask	Up to 8 areas
ROI	Up to 8 areas
Motion Detection	Up to 4 areas
<b>Smart</b>	
Behavior Detection	Intrusion, cross line, motion detection, Auto tracking
Exception Detection	Audio detection
Intelligent Identification	Face detection

Statistical Analysis	People counting
General Function	Watermark, IP Address Filtering, Tampering Alarm, Alarm input, Alarm output, Access Policy, ARP Protection, RTSP Authentication, User Authentication
<b>Audio</b>	
Audio Compression	G.711
Two-way audio	Supported
Suppression	Supported
Sampling Rate	8 KHZ
<b>Storage</b>	
Edge Storage	Micro SD, up to 128 GB
Network Storage	ANR
<b>Network</b>	
Protocols	IPv4, IGMP, ICMP, ARP, TCP, UDP, DHCP, PPPoE, RTP, RTSP, RTCP, DNS, DDNS, NTP, FTP, UPnP, HTTP, HTTPS, SMTP, 802.1x, SNMP
Compatible Integration	ONVIF(Profile S, Profile G), API
<b>Pan &amp; Tilt</b>	
Pan Range	360° (endless)
Pan Speed	0.1°/s ~ 240°/s
	Preset speed: 300°/s
Tilt Range	-15° ~ +90° (auto reverse)
Tilt Speed	0.1° ~ 160°/s
	Preset speed: 240°/s
Number of Preset	1024
Patrol	Preset patrol, route patrol, recorded patrol
Home Position	Supported
<b>Interface</b>	
Audio I/O	Audio cable
	Input: impedance 35 kΩ; amplitude 2 V [p-p]
	Output: impedance 600 Ω; amplitude 2 V [p-p]
Alarm I/O	2 / 1
Serial Port	1 RS485
Network	1 RJ45 10M/100M Base-TX Ethernet
Video Output	1 BNC, impedance 75 Ω; amplitude 1 V [p-p]
<b>General</b>	
Power	24 V AC (Default) ±25%, 24 V DC±25%
	Power consumption: 11~47W
Dimensions(∅xH)	∅227x359.4 mm (∅8.9" x 14.2")
Weight	5.5 kg (12.1 lb)
Working Environment	-40°C ~ +70°C (-40°F ~ 158°F), Humidity:10%~ 95% RH(non-condensing)
Ingress Protection	IP66
Reset Button	Supported

## Dimensions

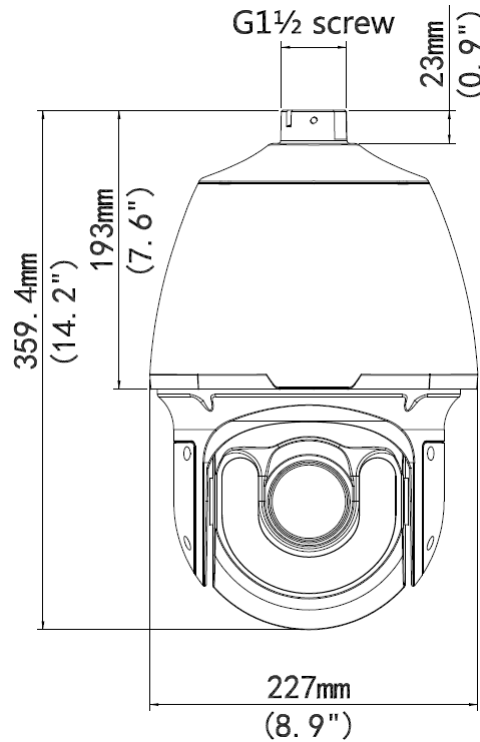

## Accessories

Installation mode	Accessories	Description
Pendant mount	TR-CE45-IN bracket	/
	Pendant components: TR-UF45-A-IN ceiling plate TR-SE45-IN pendant rod (200mm) TR-SE45-A-IN pendant rod (500mm)	Ceiling plate is optional with different pendant rod for various applications
Standing pole mount	Customized bracket	The interface is designed with internal G1½ screws. The screw depth must be more than 23 mm
Wall mount	TR-WE45-IN bracket	/
Corner mount	TR-WE45-IN bracket + TR-UC08-A/B-IN bracket	/
Pole mount	TR-WE45-IN bracket + TR-UP08-A/B-IN bracket	/

### Zhejiang Uniview Technologies Co., Ltd.

Building No.10, Wanlun Science Park, Jiangling Road 88, Binjiang District, Hangzhou, Zhejiang, China (310051)

Email: [overseasbusiness@uniview.com](mailto:overseasbusiness@uniview.com); [globalsupport@uniview.com](mailto:globalsupport@uniview.com)

<http://www.uniview.com>

©2016 -2017 Zhejiang Uniview Technologies Co., Ltd. All rights reserved.

\*Product specifications and availability are subject to change without notice.