

2MP WDR Super Starlight (Motorized) VF Network IR Bullet Camera

IPC2322EBR5-DUPZ-C



Key Features

Optics

- Super starlight illumination
- Day/night functionality
- Smart IR, up to 50m (164 ft) IR distance
- Up to 120 dB Optical WDR (Wide Dynamic Range)
- 2D/3D DNR (Digital Noise Reduction)

Compression

- Ultra 265, H.265, H.264, MJPEG
- Embedded smart algorithm
- Triple streams
- ROI (Region of Interest)
- 9:16 corridor mode
- Customized OSD

Network

- ONVIF Conformance

Structure

- Support PoE power supply
- Wide temperature range: -35°C to 60°C (-31°F to 140°F)
- Wide voltage range of $\pm 25\%$
- IP67

Specifications

	IPC2322EBR5-DUPZ-C
Camera	
Sensor	1/2.8", progressive scan, 2.0megapixel, CMOS
Lens	2.7~13.5mm, AF automatic focusing and motorized zoom lens
Angle of View(H)	120.8°~ 30.4°(H)
Shutter	Auto/Manual, shutter time: 1~1/100000 s
Minimum Illumination	Colour: 0.0005 Lux (F1.2, AGC ON) 0 Lux with IR on
Day/Night	IR-cut filter with auto switch (ICR)
Digital noise reduction	2D/3D DNR
S/N	>52 dB
IR Range	Up to 50m (164 ft) IR range
Defog	Digital Defog
WDR	120dB
Video	
Video Compression	Ultra 265, H.265, H.264, MJPEG
H.264 code profile	Baseline profile, Main Profile, High Profile
Frame Rate	Main Stream:2MP (1920×1080):Max. 30 fps; Sub Stream:2MP (1920×1080):Max. 30fps; Third Stream: D1(720×576):Max. 30fps
9:16 Corridor Mode	Supported
HLC	Supported
BLC	Supported
OSD	Up to 8 OSDs
Privacy Mask	Up to 8 areas
ROI	Up to 8 areas
Motion Detection	Up to 4 areas
Smart	
Behavior Detection	Intrusion, cross line, motion detection
Exception Detection	Audio detection
Intelligent Identification	Face detection, Defocus ,Scene Change
Statistical Analysis	People counting
General Function	Watermark, IP Address Filtering, Tampering Alarm, Alarm input, Alarm output, Access Policy, ARP Protection, RTSP Authentication, User Authentication
Audio	
Audio Compression	G.711
Two-way audio	Supported
Suppression	Supported
Sampling Rate	8 KHZ
Storage	
Edge Storage	Micro SD, up to 128 GB
Network Storage	ANR

Network	
Protocols	IPv4, IGMP, ICMP, ARP, TCP, UDP, DHCP, PPPoE, RTP, RTSP, RTCP, DNS, DDNS, NTP, FTP, UPnP, HTTP, HTTPS, SMTP, 802.1x, SNMP
Compatible Integration	ONVIF(Profile S, Profile G), API
Interface	
Audio I/O	Input: impedance 35 k Ω ; amplitude 2 V [p-p]
	Output: impedance 600 Ω ; amplitude 2 V [p-p]
Alarm I/O	1 / 1
Network	1 RJ45 10M/100M Base-TX Ethernet
General	
Power	12 V DC \pm 25%, PoE (IEEE802.3 af)
	Power consumption: Max 10W
Dimensions (L x W x H)	146.3 x 86 x 71.7 mm(57.6" x 3.4" x 2.8")
Weight	0.58kg (1.28lb)
Working Environment	-35°C ~ +60°C (-31°F ~ 140°F), Humidity :10%~ 90% RH(non-condensing)
Ingress Protection	IP67

Dimensions

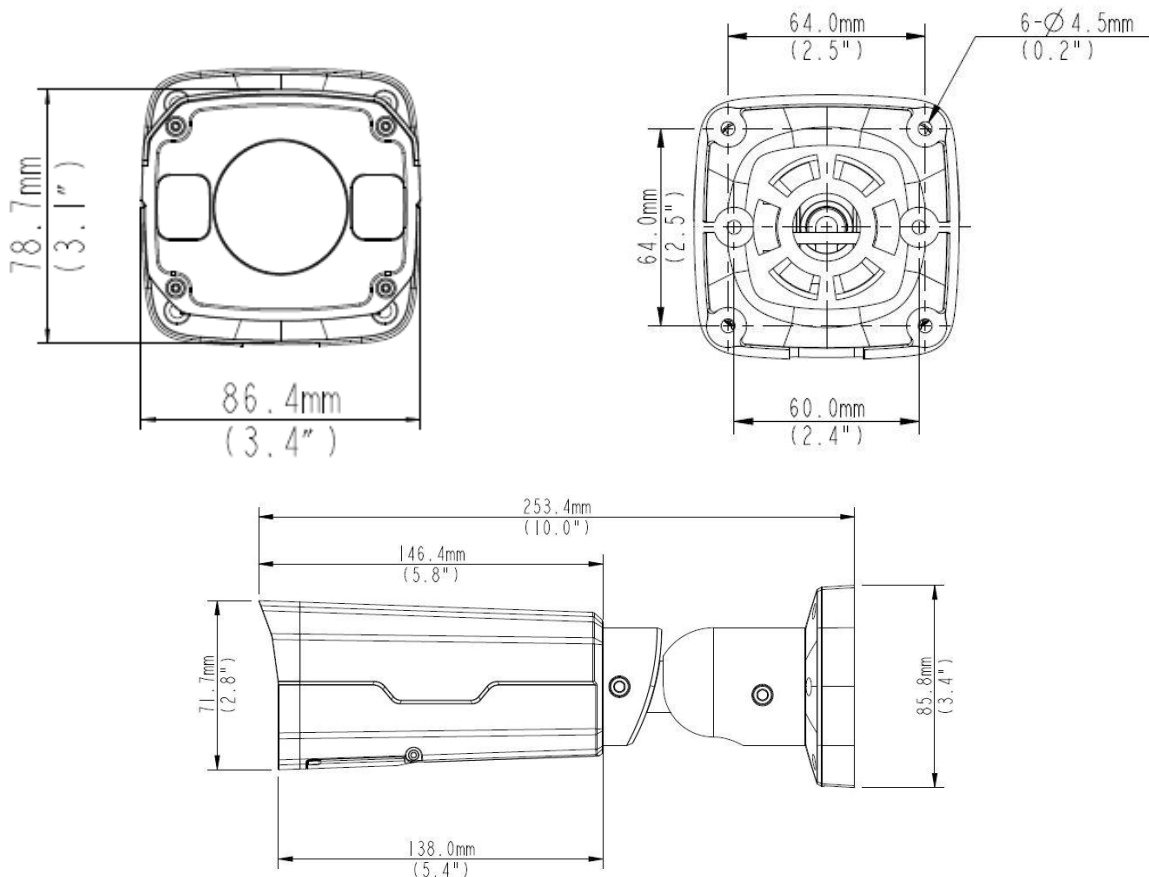

Accessories

Installation mode	Accessories	Description
Wall mount	\	Mounting pedestal is included in the Product package
Ceiling mount	\	Mounting pedestal is included in the Product package
Rail mount	TR-UP06-A-IN	For outdoor rail installation
Pole mount	TR-UP06-A-IN	For outdoor pole installation

Zhejiang Uniview Technologies Co., Ltd.

South Tower, Building 10, Wanlun Science Park, 88 Jiangling Road, Hangzhou, P.R.China 310051

Email: overseasbusiness@uniview.com; globalsupport@uniview.com

<http://www.uniview.com>

©2017 Zhejiang Uniview Technologies Co., Ltd. All rights reserved.

*Product specifications and availability are subject to change without notice.