

5MP WDR Starlight (Motorized) VF Eyeball Network IR Camera

IPC3635ER3-DUPZ



Key Features

Optics

- Starlight illumination
- Day/night functionality
- Optical glass window with higher light transmittance
- IR anti-reflection window to increase the infrared transmittance
- Smart IR, up to 30 m (98 ft) IR distance
- 2D/3D DNR (Digital Noise Reduction)
- Built-in motorized lens for remote zoom

Compression

- Ultra 265, H.265, H.264, MJPEG
- Embedded smart algorithm
- Triple streams
- 9:16 corridor mode

Network

- ONVIF Conformance

Structure

- Support PoE power supply
- Wide temperature range: -40°C to 60°C (-40°F to 140°F)
- Wide voltage range of ±25%
- IP67

Specifications

	IPC3635ER3-DUPZ
Camera	
Sensor	1/2.7", progressive scan, 5.0 megapixel, CMOS
Lens	2.7~13.5 mm, AF automatic focusing and motorized zoom lens
Angle of view(H)	104.2° ~ 28.3°(H)
Shutter	Auto/Manual, shutter time: 1~1/100000 s
Minimum Illumination	Colour: 0.001 Lux (F1.2, AGC ON) 0 Lux with IR
Day/Night	IR-cut filter with auto switch (ICR)
Digital noise reduction	2D/3D DNR
S/N	>52dB
IR Range	Up to 30m (98 ft) IR range
Defog	Digital Defog
WDR	120dB
Video	
Video Compression	Ultra 265,H.265, H.264, MJPEG
H.264 code profile	Baseline profile, Main Profile, High Profile
Frame Rate	Main Stream: 5MP(2592 x 1944): Max. 20 fps, 4MP(2560 x 1440): Max. 30 fps, 3MP(2048x 1536): Max. 30 fps, 2MP(1920 x 1080): Max. 30 fps; Sub Stream:2MP(1920 x 1080): Max. 30 fps; Third Stream: D1(720 x 576): Max.3 0 fps;
9:16 Corridor Format	Supported
HLC	Supported
BLC	Supported
OSD	Up to 8 OSDs
Privacy Mask	Up to 8 areas
ROI	Up to 8 areas
Motion Detection	Up to 4 areas
Smart	
Behavior Detection	Intrusion, cross line, motion detection
Intelligent Identification	Face detection, Defocus, Scene Change
Statistical Analysis	People counting
General Function	Watermark, IP Address Filtering, Tampering Alarm, Access Policy, ARP Protection, RTSP Authentication, User Authentication
Audio	

Audio Compression	G.711
Suppression	Supported
Sampling Rate	8 KHZ
Storage	
Edge Storage	Micro SD, up to 128 GB
Network Storage	ANR
Network	
Protocols	IPv4, IGMP, ICMP, ARP, TCP, UDP, DHCP, PPPoE, RTP, RTSP, RTCP, DNS, DDNS, NTP, FTP, UPnP, HTTP, HTTPS, SMTP, 802.1x, SNMP
Compatible Integration	ONVIF(Profile S, Profile G),API
Interface	
Network	1 RJ45 10M/100M Base-TX Ethernet
Built-in Mic	Supported
General	
Power	12 V DC \pm 25%, PoE (IEEE802.3 af)
	Power consumption: Max 8.16W
Dimensions (\varnothing x H)	\varnothing 129 x 110 mm (\varnothing 5.08" x 4.3")
Weight	0.67 kg (1.48lb)
Working Environment	-40°C ~ +60°C (-40°F ~ 140°F), Humidity: 10%~90% RH(non-condensing)
Ingress Protection	IP67
Reset Button	Supported

Dimensions

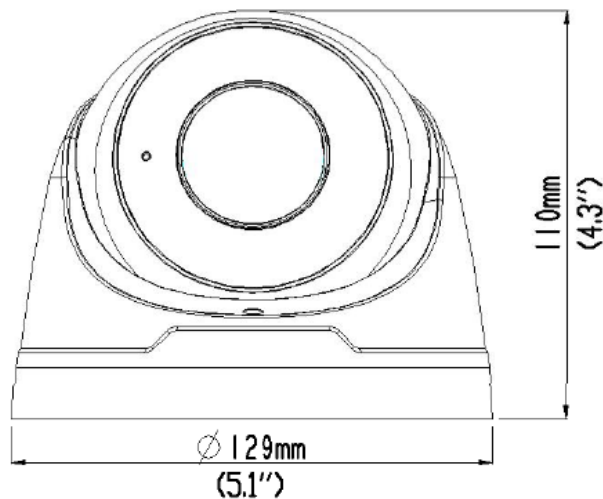

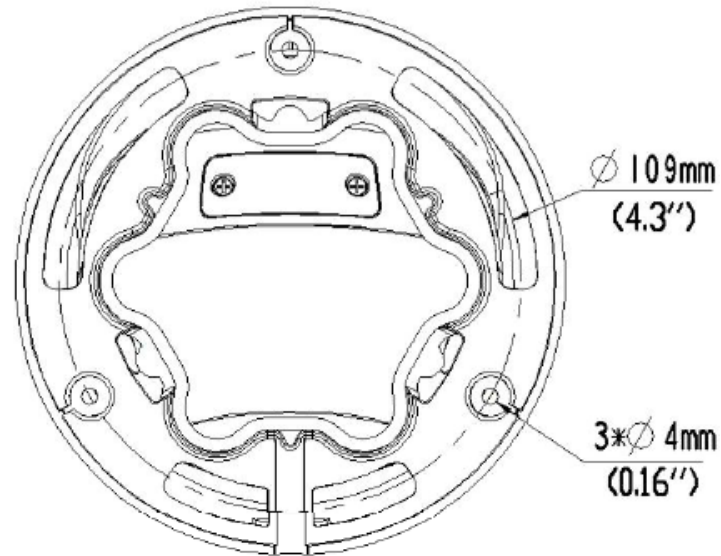

Accessories

Installation mode	Accessories	Description
Ceiling mount	Mounting pedestal is included in the product package	TR-JB03-B-IN junction box and TR-A01-IN waterproof joint for the junction is optional
Wall mount	TR-WM03-A-IN	For indoor wall installation, excluding junction box
	TR-JB07/WM03-A-IN (Or TR-JB07/WM03-B-IN)	For outdoor wall installation, including junction box TR-A01-IN waterproof joint for the junction is optional
	TR-JB07/WM03-A-IN (Or TR-JB07/WM03-B-IN)+TR-UP06-IN	For outdoor wall installation, including junction box
Pendant mount	TR-WM03-A-IN+TR-UP06-IN	For indoor pendent installation

Zhejiang Uniview Technologies Co., Ltd.

South Tower, Building 10, Wanlun Science Park, 88 Jiangling Road, Hangzhou, P.R.China 310051

Email: overseasbusiness@uniview.com; globalsupport@uniview.com

<http://www.uniview.com>

©2017 Zhejiang Uniview Technologies Co., Ltd. All rights reserved.

*Product specifications and availability are subject to change without notice.