

2MP 38x Starlight IR Network PTZ Dome Camera

IPC6852SR-X38UG



Key Features

Optics

- Starlight illumination
- Accurate and fast focusing
- Smart IR, up to 250 m (820ft) IR distance
- Optical glass window with higher light transmittance
- IR anti-reflection window to increase the infrared transmittance

Compression

- Ultra 265, H.265, H.264, MJPEG
- Embedded smart algorithm
- Triple streams
- Customized OSD

Network

- ONVIF Conformance
- Optional network interfaces with Ethernet RJ45 and optical SFP

Structure

- Innovative snow-removing functionality
- More effective heat dissipation system
- Intelligent temperature control technology

- IP66
- IK10

Specifications

IPC6852SR-X38UG	
Camera	
Sensor	1/1.9", progressive scan, 2.0megapixel, CMOS
Lens	5.7 ~ 216.6 mm (38x optical zoom) , AF automatic focusing and motorized zoom lens
Angle of View (H)	58.4° (wide) ~ 2.08° (tele)
Shutter	Auto/Manual; shutter time: 1s ~ 1/100000 s
Minimum Illumination	Colour: 0.001Lux (F1.5, AGC ON) 0 Lux with IR
Iris	Auto/Manual; F1.5 ~ F4.5
Day/Night	IR-cut filter with auto switch (ICR)
Digital noise reduction	2D/3D DNR
S/N	>52dB
IR Range	UP to 250m (820ft)
Defog	Optical Defog & Digital Defog
WDR	120dB
Video	
Video Compression	Ultra 265,H.265, H.264, MJPEG
H.264 code profile	Baseline profile, Main Profile, High Profile
Frame Rate	Main Stream:2MP (1920×1080):Max. 60 fps; Sub Stream:2MP (1920×1080):Max. 60 fps; Third Stream: D1 (720×576): Max. 60 fps
HLC	Supported
BLC	Supported
EIS	Supported
OSD	Up to 8 OSDs
Privacy Mask	Up to 8 areas
ROI	Up to 8 areas
Motion Detection	Up to 4 areas
Smart	
Behavior Detection	Intrusion, cross line, motion detection, Auto tracking
Exception Detection	Audio detection
Intelligent Identification	Face detection
Statistical Analysis	People counting
General Function	Watermark, IP Address Filtering, Tampering Alarm, Alarm input, Alarm output, Access Policy, ARP Protection, RTSP Authentication, User Authentication
Audio	
Audio Compression	G.711

Two-way audio	Supported
Suppression	Supported
Sampling Rate	8 KHZ
Storage	
Edge Storage	Micro SD, up to 128 GB
Network Storage	ANR
Network	
Protocols	IPv4, IGMP, ICMP, ARP, TCP, UDP, DHCP, PPPoE, RTP, RTSP, RTCP, DNS, DDNS, NTP, FTP, UPnP, HTTP, HTTPS, SMTP, 802.1x, SNMP
Compatible Integration	ONVIF(Profile S, Profile G), API
Pan & Tilt	
Pan Range	360° (endless)
Pan Speed	0.1°/s ~ 240°/s
	Preset speed: 300°/s
Tilt Range	-20° ~ +90° (auto reverse)
Tilt Speed	0.1° ~ 160°/s
	Preset speed: 240°/s
Number of Presets	1024
Patrol	Preset patrol, route patrol, recorded patrol
Home Position	Supported
Interface	
Audio I/O	Audio cable
	Input: impedance 35 kΩ; amplitude 2 V [p-p]
	Output: impedance 600 Ω; amplitude 2 V [p-p]
Alarm I/O	2 / 1
Serial Port	1 RS485
Network	1 RJ45 10M/100M/1000M Base-TX Ethernet SFP Base-TX Ethernet
Video Output	1 BNC, impedance 75 Ω; amplitude 1 V [p-p]
General	
Power	24 V AC (Default) ±25%, 24 V DC±25%
	Power consumption: 106~51W
Dimensions(ØxH)	Φ270 x 496.7mm (Φ10.6" x 19.6")
Weight	9.69 kg (21.4 lb)
Working Environment	-40°C ~ +70°C (-40°F ~ 158°F), Humidity:10%~ 90% RH(non-condensing)
Ingress Protection	IP66
Vandal Resistant	IK10
Reset Button	Supported

Dimensions

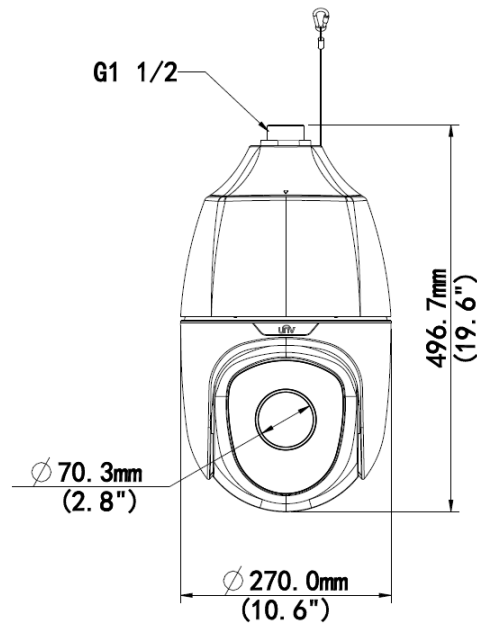

Accessories

Installation mode	Accessories	Description
Pendant mount	TR-CE45-IN bracket	/
	Pendant components: TR-UF45-A-IN ceiling plate TR-SE45-IN pendant rod (200mm) TR-SE45-A-IN pendant rod (500mm)	Ceiling plate is optional with different pendant rod for various applications
Standing pole mount	Customized bracket	The interface is designed with internal G1½ screws. The screw depth must be more than 23 mm
Wall mount	TR-WE45-IN bracket	/
Corner mount	TR-WE45-IN bracket + TR-UC08-A/B-IN bracket	/
Pole mount	TR-WE45-IN bracket + TR-UP08-A/B-IN bracket	/

Zhejiang Uniview Technologies Co., Ltd.

Building No.10, Wanlun Science Park, Jiangling Road 88, Binjiang District, Hangzhou, Zhejiang, China (310051)

Email: overseasbusiness@uniview.com; globalsupport@uniview.com

<http://www.uniview.com>

©2018 Zhejiang Uniview Technologies Co., Ltd. All rights reserved.

*Product specifications and availability are subject to change without notice.