

4MP Fisheye Fixed Dome Network Camera

IPC814SR-DVSPF16



Key Features

Optics

- Ultra wide angle lens, 180° panoramic image
- Smart IR, Up to 10 m (33ft) IR distance
- 2D/3D DNR (Digital Noise Reduction)

Compression

- Ultra265, H.265, H.264, MJPEG
- Triple stream (3 panoramic view)

Network

- ONVIF Conformance

Structure

- Support PoE power supply
- Wide temperature range: -40°C to 60°C (-40°F to 140°F)
- Wide voltage range of $\pm 25\%$
- IK10
- IP66

Specifications

	IPC814SR-DVSPF16
Camera	
Image sensor	1/3", progressive scan, 4.0 megapixel, CMOS
Lens	1.6mm@ F1.6
Angle of View (H)	180°
Shutter	Auto/Manual, shutter time: 1/6 s ~1/100000 s
Minimum Illumination	Colour: 0.01 Lux (F1.6, AGC ON) 0 Lux with IR
Day / Night	IR-cut filter for day & night function
Digital noise reduction	2D/3D DNR
S/N Ratio	>55dB
IR Range	UP to 10m(33 ft)
Defog	Digital Defog
WDR	120dB
Video	
Compression	Ultra265, H.265, H.264,MJPEG
H.264 code profile	Baseline profile, Main Profile, High Profile
Frame Rate	Main Stream : (2560×1440) : Max.25fps; Sub Stream: (1920×1080) : Max.25fps; Third Stream: D1(720 x 576): Max.25fps
BLC	Supported
OSD	Up to 8 OSDs
Privacy Mask	Up to 8 areas
ROI	Up to 8 areas
Motion Detection	Up to 4 areas
General Function	Watermark, IP Address Filtering, Tampering Alarm, Access Policy, ARP Protection, RTSP Authentication, User Authentication
Storage	
Edge Storage	Micro SD, up to 128GB
Network Storage	ANR
Network	
Protocols	IPv4, IGMP, ICMP, ARP, TCP, UDP, DHCP, PPPoE, RTP, RTSP, RTCP, DNS, DDNS, NTP, FTP, UPnP, HTTP, HTTPS, SMTP, 802.1x, SNMP
Compatible Integration	ONVIF(Profile S, Profile G), API
Live View Display	
Mount Type	Support table, wall, and ceiling
Display Mode	Support 9 display modes in total (including display modes of mount types and decoding modes): Original Image, Fisheye+4PTZ, Panoramic, 360°Panoramic+1PTZ, 180°Panoramic, Fisheye+3PTZ, Fisheye+4PTZ, 360°Panoramic+6PTZ, Fisheye+8PTZ
Interface	
Network	1 RJ45 10M/100M Base-TX Auto-adaptive Ethernet
General	
Power	DC12V±25%,PoE(IEEE 802.3af)
	Power consumption: Max. 11 W

Dimensions (Ø x H)	Φ125x 43.7 mm (Φ4.9" x 1.7")
Weight	0.39kg(0.86lb)
Working Environment	-40°C ~60°C (-40°F ~ 140°F), Humidity :10%~95% RH
Ingress Protection	IP66
Vandal Resistant	IK10
Reset Button	Supported

Dimensions

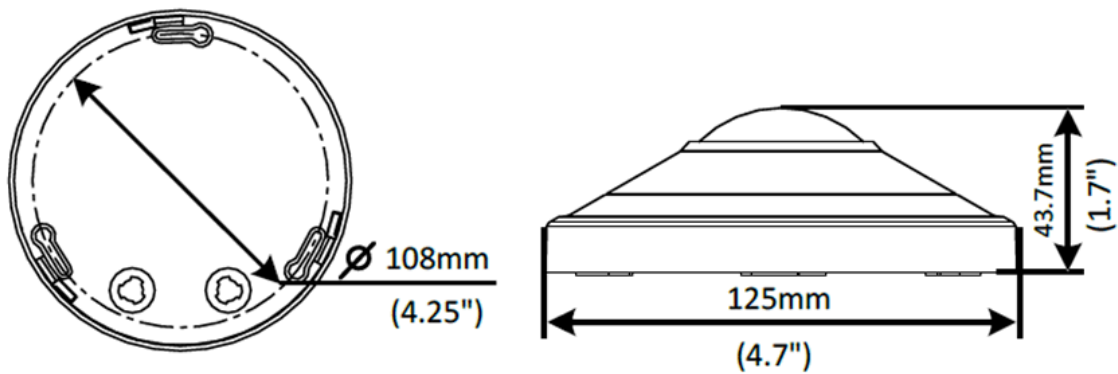

Zhejiang Uniview Technologies Co., Ltd.

Building No.10, Wanlun Science Park, Jiangling Road 88, Binjiang District, Hangzhou, Zhejiang, China (310051)

Email: overseasbusiness@uniview.com; globalsupport@uniview.com

<http://www.uniview.com>

©2016-2018 Zhejiang Uniview Technologies Co., Ltd. All rights reserved.

*Product specifications and availability are subject to change without notice.