

# 2MP WDR (Motorized)VF Eyeball Network IR Camera

IPC3632ER3-DPZ28-C



## Key Features

### Optics

- Day/night functionality
- Optical glass window with higher light transmittance
- IR anti-reflection window to increase the infrared transmittance
- Smart IR, up to 30 m (98 ft) IR distance
- 2D/3D DNR (Digital Noise Reduction)

### Compression

- Ultra 265, H.265, H.264, MJPEG
- Embedded smart algorithm
- Triple streams
- 9:16 corridor mode

### Network

- ONVIF Conformance

## Structure

- Support PoE power supply
- Wide temperature range: -40°C to 60°C (-40°F to 140°F)
- Wide voltage range of ±25%
- IP67

## Specifications

IPC3632ER3-DPZ28-C	
<b>Camera</b>	
Sensor	1/2.9", progressive scan, 2.0 megapixel, CMOS
Lens	2.7~12mm, AF automatic focusing and motorized zoom lens
Angle of view(H)	94.0°~28.0°
Shutter	Auto/Manual, 1/6~1/100000 s
Minimum Illumination	Colour: 0.01 Lux (F1.4, AGC ON) 0 Lux with IR
Day/Night	IR-cut filter with auto switch (ICR)
Digital noise reduction	2D/3D DNR
S/N	>52dB
IR Range	Up to 30m (98 ft) IR range
Defog	Digital Defog
WDR	120dB
<b>Video</b>	
Video Compression	Ultra 265, H.265, H.264, MJPEG
H.264 code profile	Baseline profile, Main Profile, High Profile
Frame Rate	Main Stream: 2MP (1920×1080): Max. 30 fps; Sub Stream: 2MP (1920×1080): Max. 30 fps; Third Stream: D1 (720×576): Max. 30 fps
HLC	Supported
BLC	Supported
9:16 Corridor Mode	Supported
OSD	Up to 8 OSDs
Privacy Mask	Up to 8 areas
ROI	Up to 8 areas
Motion Detection	Up to 4 areas
<b>Smart</b>	
Behavior Detection	Intrusion, cross line, motion detection
Intelligent Identification	Face detection, Defocus, Scene Change
Statistical Analysis	People counting
General Function	Watermark, IP Address Filtering, Tampering Alarm, Access Policy, ARP Protection, RTSP Authentication, User Authentication
<b>Audio</b>	
Audio Compression	G.711

Suppression	Supported
Sampling Rate	8 KHZ
<b>Storage</b>	
Edge Storage	Micro SD, up to 128 GB
Network Storage	ANR
<b>Network</b>	
Protocols	IPv4, IGMP, ICMP, ARP, TCP, UDP, DHCP, PPPoE, RTP, RTSP, RTCP, DNS, DDNS, NTP, FTP, UPnP, HTTP, HTTPS, SMTP, 802.1x, , SNMP
Compatible Integration	ONVIF(Profile S, Profile G), API
<b>Interface</b>	
Built-in Mic	Supported
Network	1 RJ45 10M/100M Base-TX Ethernet
<b>General</b>	
Power	12 V DC±25%, PoE (IEEE802.3 af)
	Power consumption: Max 8.16W
Dimensions (∅ x H)	∅129 x 110 mm (∅5.08" x 4.3")
Weight	0.67 kg (1.48lb)
Working Environment	-40°C ~ +60°C (-40°F ~ 140°F), Humidity:10%~95% RH(non-condensing)
Ingress Protection	IP67
Reset Button	Supported

## Dimensions

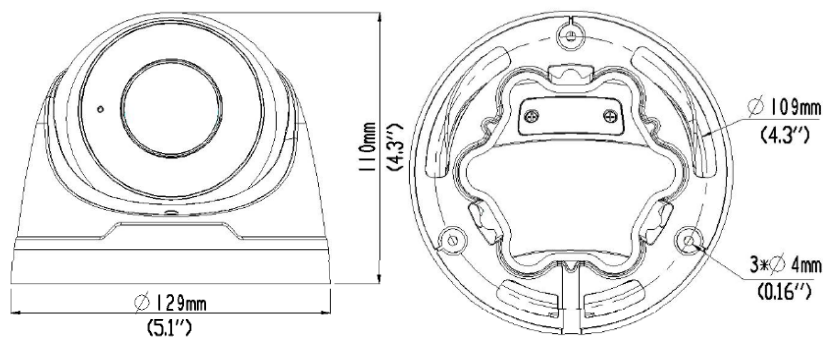

### Zhejiang Uniview Technologies Co., Ltd.

South Tower, Building 10, Wanlun Science Park, 88 Jiangling Road, Hangzhou, P.R.China 310051

Email: [overseasbusiness@uniview.com](mailto:overseasbusiness@uniview.com); [globalsupport@uniview.com](mailto:globalsupport@uniview.com)

<http://www.uniview.com>

©2016-2018 Zhejiang Uniview Technologies Co., Ltd. All rights reserved.

\*Product specifications and availability are subject to change without notice.