

4MP SD Card MiniFixed Bullet Network Camera

IPC2124ER3-DPF40 (60)



Key Features

Optics

- Day/night functionality
- SmartIR ,up to 30 m (98 ft) IR distance
- Optical glass window with higher light transmittance
- IR anti-reflection window to increase the infrared transmittance
- 2D/3D DNR (Digital Noise Reduction)
- SD Card

Compression

- Ultra 265,H.265, H.264, MJPEG
- Embedded smart algorithm
- Triple streams
- 9:16 corridor format

Network

- ONVIF Conformance

Structure

- Wide temperature range: -35°C to 60°C (-31°F to 140°F)
- Wide voltage range of $\pm 25\%$
- IP67
- 3-Axis

Specifications

	IPC2124ER3-DPF40	IPC2124ER3-DPF60			
Camera					
Sensor	1/3", megapixel, 4.0 progressive scan, CMOS				
Lens	4.0mm@F2.0		6.0mm@F2.0		
DORI Distance	Lens	Detect(m)	Observe(m)	Recognize(m)	Identify(m)
	4mm	90	36	18	9
	6mm	135	54	27	13.5
Angle of View(H)	78.9°		49.9°		
Angle of View (V)	39.6°		27°		
Angle of View (O)	97.1°		61.4°		
Adjustment angle	Pan: 0°~360°		Tilt: 0°~90°		Rotate: 0°~360°
Shutter	Auto/Manual, 1~1/100000 s				
Minimum Illumination	Colour: 0.03Lux (F2.0, AGC ON) 0 Lux with IR on				
Day/Night	IR-cut filter with auto switch (ICR)				
Digital noise reduction	2D/3D DNR				
S/N	>52dB				
IR Range	Up to 30m (98 ft) IR range				
Defog	Digital Defog				
WDR	120dB				
Video					
Video Compression	Ultra 265, H.265, H.264, MJPEG				
H.264 code profile	Baseline profile, Main Profile, High Profile				
Frame Rate	Main Stream: 4MP (2592×1520): Max. 20 fps, 4MP (2560×1440): Max. 25 fps, 3MP (2048×1520): Max. 30 fps; Sub Stream: 2MP (1920×1080): Max. 30 fps; Third Stream: D1 (720×576) : Max. 30fps				
9:16 Corridor Mode	Supported				
HLC	Supported				
BLC	Supported				
OSD	Up to 8 OSDs				

Privacy Mask	Up to 8 areas
ROI	Up to 8 areas
Motion Detection	Up to 4 areas
Smart	
Behavior Detection	Intrusion, cross line, motion detection
Intrusion	Enter and loiter in a pre-defined virtual region
cross line	Cross a pre-defined virtual line
motion detection	Moving within a pre-defined virtual region
Recognition	Face detection
Intelligent Identification	Defocus, Scene Change, Object Left, Object Moving
Statistical Analysis	People counting
General Function	Watermark, IP Address Filtering, Tampering Alarm, Access Policy, ARP Protection, RTSP Authentication, User Authentication
Storage	
Edge Storage	Micro SD, Up to 128 GB
Network Storage	ANR
Network	
Protocols	IPv4, IGMP, ICMP, ARP, TCP, UDP, DHCP, PPPoE, RTP, RTSP, RTCP, DNS, DDNS, NTP, FTP, UPnP, HTTP, HTTPS, SMTP, 802.1x, SNMP
Compatible Integration	ONVIF(Profile S, Profile G), API
Interface	
Network	1 RJ45 10M/100M Base-TX Ethernet
General	
Power	12 V DC±25%,PoE (IEEE802.3 af)
	Power consumption: Max 6.5W
Dimensions (L × W × H)	157.3 × 62.4 × 63 mm(6.2" × 2.5" × 2.5")
Weight	0.45 kg (0.99lb)
Working Environment	-35°C ~ +60°C (-31°F ~ 140°F), Humidity :10%~95% RH(non-condensing)
Ingress Protection	IP67
Reset Button	Supported

Dimensions

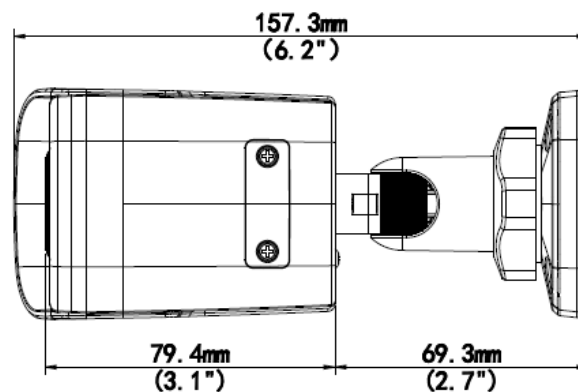

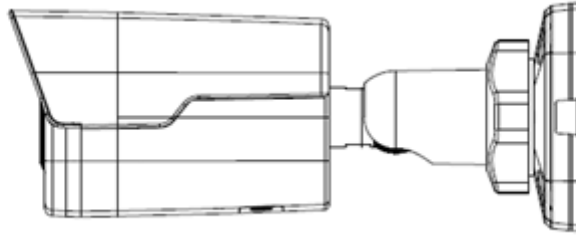
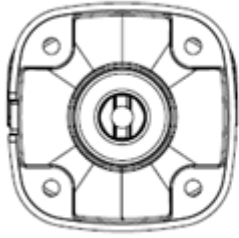

Zhejiang Uniview Technologies Co., Ltd.

Building No.10, Wanlun Science Park, Jiangling Road 88, Binjiang District, Hangzhou, Zhejiang, China (310051)

Email: overseasbusiness@uniview.com; globalsupport@uniview.com

<http://www.uniview.com>

©2018 Zhejiang Uniview Technologies Co., Ltd. All rights reserved.

*Product specifications and availability are subject to change without notice.