

4MP Fixed Dome Network Camera

IPC3614LR3-PF28(40)-D



Key Features

Optics

- Day/night functionality
- Smart IR, up to 30 m (98 ft) IR distance
- 3D DNR (Digital Noise Reduction)

Compression

- Ultra 265,H.265,H.264,MJPEG
- ROI (Region of Interest)

Network

- ONVIF Conformance

Structure

- Wide temperature range: -30°C to 60°C (-22°F to 140°F)
- Wide voltage range of $\pm 25\%$
- IP67
- 3-Axis

Specifications

	IPC3614LR3-PF28-D	IPC3614LR3-PF40-D			
Camera					
Sensor	1/3", 4.0 megapixel, progressive scan, CMOS				
Lens	2.8mm@F2.0		4.0mm@2.0		
DORI Distance	Lens	Detect(m)	Observe(m)	Recognize(m)	Identify(m)
	2.8mm	42	16.8	8.4	4.2
	4.0mm	60	24	12	6
Angle of view(H)	104.4°		78.9°		
Angle of View (V)	54.4°		39.6°		
Angle of View (O)	135.7°		97.0°		
Shutter	Auto/Manual, 1~1/100000 s				
Adjustment angle	Pan: 0°~360°		Tilt: 0°~90°		Rotate: 0°~360°
Min. Illumination	Colour: 0.03 Lux (2.0, AGC ON) 0 Lux with IR				
IR Range	Up to 30m (98 ft) IR range				
Day/Night	IR-cut filter with auto switch (ICR)				
S/N	>52dB				
WDR	DWDR				
Noise Reduction	2D/3D				
Video					
Video Compression	Ultra 265,H.265,H.264,MJPEG				
Frame Rate	Main Stream:4MP (2592*1520): Max. 20 fps; Sub Stream:720P (1280*720): Max. 20 fps; Third Stream:D1 (720*576): Max. 20 fps				
HLC	Supported				
BLC	Supported				
OSD	Up to 4 OSDs				
Privacy Mask	Up to 8 areas				
ROI	Up to 2 areas				
Motion Detection	Up to 4 areas				
Network					
Protocols	IPv4,IGMP,ICMP,ARP,TCP,UDP,DHCP, RTP,RTSP,RTCP,DNS,DDNS,NTP,FTP,UPnP,HTTP,HTTPS,SMTP, SSL				
Compatible Integration	ONVIF(Profile S,Profile T),API				
Interface					
Network	10/100M Base-TX Ethernet				
General					
Power	12 V DC±25%, PoE (IEEE802.3 af)				
	Power consumption: Max 4W				
Dimensions (∅ x H)	∅118x 96 mm (∅4.6" x 3.8")				
Weight	0.35kg (0.77lb)				
Working Environment	-30°C ~ +60°C (-22°F ~ 140°F), Humidity :10%~90% RH(non-condensing)				
Ingress Protection	IP67				

Dimensions

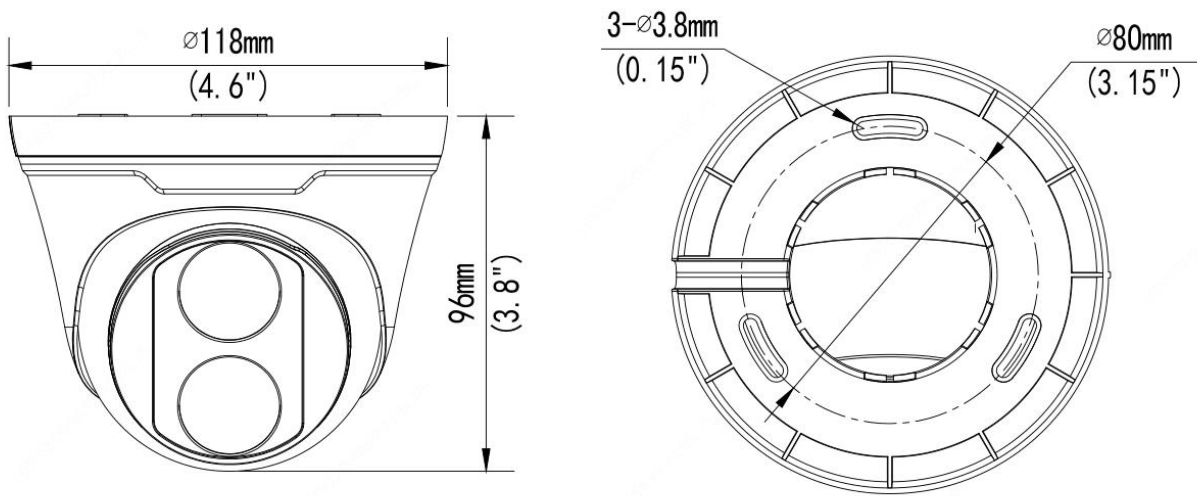

Zhejiang Uniview Technologies Co., Ltd.

South Tower, Building 10, Wanlun Science Park, 88 Jiangling Road, Hangzhou, P.R.China 310051

Email: overseasbusiness@uniview.com; globalsupport@uniview.com

<http://www.uniview.com>

©2018 Zhejiang Uniview Technologies Co., Ltd. All rights reserved.

*Product specifications and availability are subject to change without notice.