

2MP WDR VF Vandal-resistant IR Dome Network Camera

IPC3232ER3-DVZ28-C

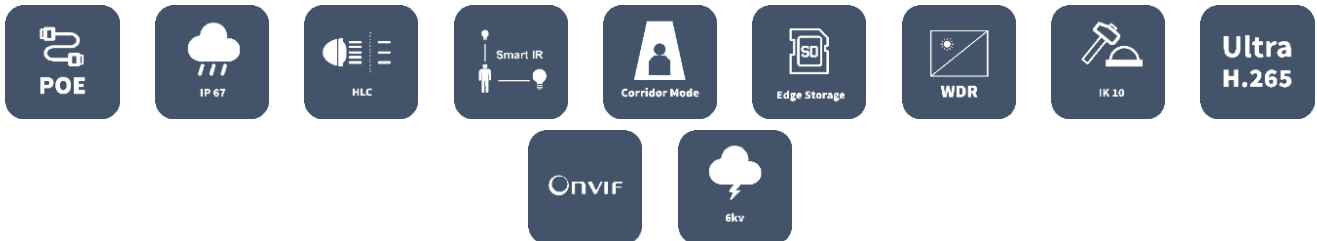

Key Features



Optics

- Day/night functionality
- Smart IR, up to 30m (98ft) IR distance
- Up to 120dB Optical WDR (Wide Dynamic Range)
- 2D/3D DNR (Digital Noise Reduction)
- Built-in motorized lens for remote zoom

Compression

- Ultra 265, H.265, H.264, MJPEG
- Triple streams
- ROI (Region of Interest)
- 9:16 corridor mode

Network

- ONVIF Conformance

Structure

- Support PoE power supply
- Built-in PoE splitter that outputs DC 12V
- Wide temperature range: -40°C ~ 60°C (-40°F ~ 140°F)
- Wide voltage range of ±25%
- IK10 vandal resistant
- IP67
- 3-Axis

Specifications

IPC3232ER3-DVZ28-C																
Camera																
Sensor	1/2.8", 2.0 megapixel, progressive scan, CMOS															
Lens	2.8 ~ 12mm, AF automatic focusing and motorized zoom lens															
DORI Distance	<table border="1"> <thead> <tr> <th>Lens (mm)</th> <th>Detect (m)</th> <th>Observe (m)</th> <th>Recognize (m)</th> <th>Identify (m)</th> </tr> </thead> <tbody> <tr> <td>2.8</td> <td>43.4</td> <td>17.4</td> <td>8.7</td> <td>4.3</td> </tr> <tr> <td>12</td> <td>186.2</td> <td>74.5</td> <td>37.2</td> <td>18.6</td> </tr> </tbody> </table>	Lens (mm)	Detect (m)	Observe (m)	Recognize (m)	Identify (m)	2.8	43.4	17.4	8.7	4.3	12	186.2	74.5	37.2	18.6
	Lens (mm)	Detect (m)	Observe (m)	Recognize (m)	Identify (m)											
	2.8	43.4	17.4	8.7	4.3											
12	186.2	74.5	37.2	18.6												
Angle of View (H)	94.0° ~ 28°															
Angle of View (V)	56.7° ~ 14.4°															
Angle of View (O)	122.2° ~ 34.4°															
Adjustment angle	<table border="1"> <tr> <td>Pan: 0° ~ 360°</td> <td>Tilt: 0° ~ 80°</td> <td>Rotate: 0° ~ 360°</td> </tr> </table>	Pan: 0° ~ 360°	Tilt: 0° ~ 80°	Rotate: 0° ~ 360°												
Pan: 0° ~ 360°	Tilt: 0° ~ 80°	Rotate: 0° ~ 360°														
Shutter	Auto/Manual, 1 ~ 1/100000s															
Minimum Illumination	Colour: 0.002Lux (F1.6, AGC ON) 0Lux with IR															
Day/Night	IR-cut filter with auto switch (ICR)															
S/N	>52dB															
IR Range	Up to 30m (98ft) IR range															
wavelength	850nm															
IR On/Off Control	Auto/Manual															
Defog	Digital Defog															
WDR	120dB															
Video																
Video Compression	Ultra 265, H.265, H.264, MJPEG															
H.264 code profile	Baseline profile, Main Profile, High Profile															
Frame Rate	Main Stream: 2MP (1920*1080), Max 30fps;															

	Sub Stream: 2MP (1920*1080), Max 30fps; Third Stream: D1 (720*576), Max 30fps
Video Bit Rate	128 Kbps~16 Mbps
9:16 Corridor Mode	Supported
OSD	Up to 8 OSDs
Privacy Mask	Up to 8 areas
ROI	Up to 8 areas
Motion Detection	Up to 4 areas
Image	
White Balance	Auto/Outdoor/Fine Tune/Sodium Lamp/Locked/Auto2
Digital noise reduction	2D/3D DNR
Smart IR	Support
Flip	Normal/Vertical/Horizontal/180°/90°Clockwise/90°Anti-clockwise
Dewarping	N/A
HLC	Support
BLC	Support
Audio	
Audio Compression	G.711
Two-way audio	Supported
Suppression	Supported
Sampling Rate	8KHZ
Storage	
Edge Storage	Micro SD, up to 256GB
Network Storage	ANR, NAS(NFS)
Network	
Protocols	IPv4, IGMP, ICMP, ARP, TCP, UDP, DHCP, PPPoE, RTP, RTSP, RTCP, DNS, DDNS, NTP, FTP, UPnP, HTTP, HTTPS, SMTP, 802.1x, SNMP, QoS
Compatible Integration	ONVIF (Profile S, Profile G, Profile T), API
Client	EZStation EZView EZLive
Web Browser	Plug-in required live view: IE9+, Chrome 41 and below, Firefox 52 and below
	Plug-in free live view: Chrome 57.0+, Firefox 58.0+, Edge 16+, Safari 11+
Interface	
Audio I/O	Audio cable
	Input: impedance 35kΩ; amplitude 2V [p-p]
	Output: impedance 600Ω; amplitude 2V [p-p]
Alarm I/O	1/1
Network	1 RJ45 10M/100M Base-TX Ethernet
Video Output	1 BNC, impedance 75Ω; amplitude 1V [p-p]
Certifications	
Certifications	CE: EN 60950-1 UL: UL60950-1 FCC: FCC Part 15

General

Power	DC 12V±25%, PoE (IEEE 802.3af)
	Power consumption: Max 7.2W
Dimensions (Ø x H)	Φ148 x 111.3mm (Ø5.8" x 4.4")
Net Weight	0.92kg (2.0lb)
Material	Metal + Plastic
Working Environment	-40°C ~ 60°C (-40°F ~ 140°F), Humidity: ≤95% RH (non-condensing)
Storage Environment	-40°C ~ 60°C (-40°F ~ 140°F), Humidity: ≤95% RH (non-condensing)
surge protection	6KV
Ingress Protection	IP67
Vandal Resistant	IK10
Reset Button	Supported

Dimensions

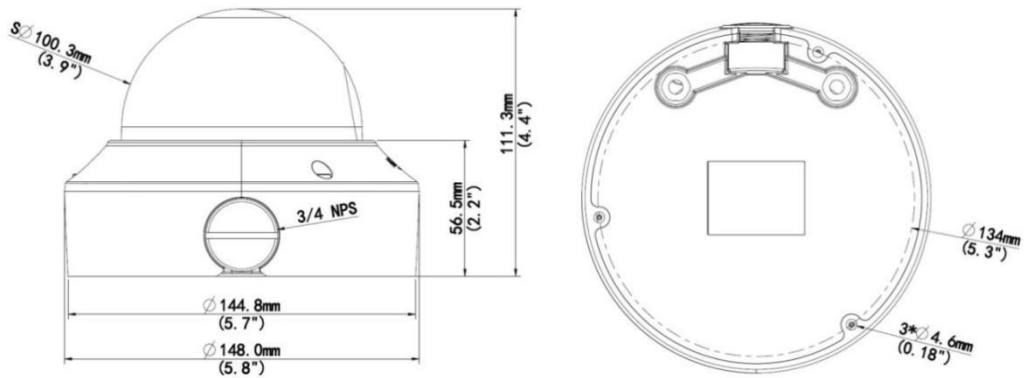

Accessories

TR-JB04-C-IN



TR-JB07/WM04-B-IN



TR-WM04-IN



TR-FM152-A-IN



TR-SM04-IN



TR-A01-IN



TR-UP06-IN



TR-SE24-IN



TR-SE24-A-IN

TR-CM24-IN

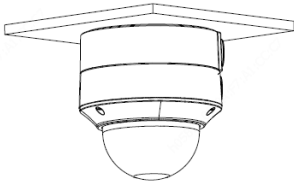
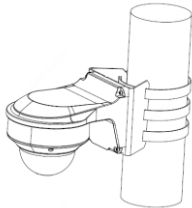
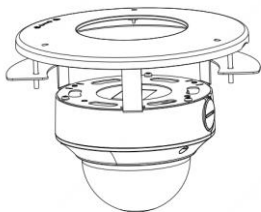
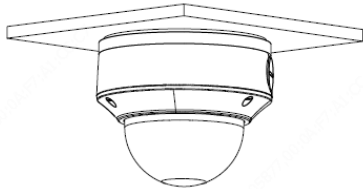
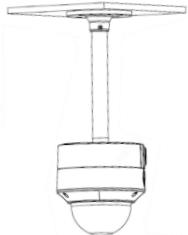

Junction box	Pole mount
TR-JB04-C-IN+TR-A01-IN	TR-JB07/WM04-B-IN (TR-WM04-IN)+ TR-UP06-IN
	
In-ceiling mount	Electric-box Transfer plate
TR-FM152-A-IN	TR-SM04-IN
	
Indoor pendent mount	
TR-JB04-D-IN+TR-A01-IN+ TR-SE24-IN(TR-SE24-A-IN)+ TR-CM24-IN	
	

Zhejiang Uniview Technologies Co., Ltd.

Building No.10, Wanlun Science Park, Jiangling Road 88, Binjiang District, Hangzhou, Zhejiang, China (310051)

Email: overseasbusiness@uniview.com; globalsupport@uniview.com

<http://www.uniview.com>

©2019 Zhejiang Uniview Technologies Co., Ltd. All rights reserved.

*Product specifications and availability are subject to change without notice.